



Apex Chromatography Pvt. Ltd.

The complete solution for all your analytical needs



CHROMACCESS

Chromatography Accessories



WORLD CLASS CHROMATOGRAPHY CONSUMABLES
BROUGHT TO YOU IN INDIA EXCLUSIVELY BY



Apex Chromatography Pvt. Ltd.

The complete solution for all your analytical needs



Hichrom Limited

Experts in Chromatography

Vydac | Alltima | Alltima HP | Apex | Apollo | Allsep | Genesis | Prevail

USP Listings :::: Hichrom - Grace Columns

The following list of USP (United States Pharmacopoeia) column specifications includes the recommended columns contained in this catalogue within each category. Please contact us for advice on column selection by USP specification.

USP Code	Definition	Columns
L1	Octadecylsilane chemically bonded to porous or non-porous silica or ceramic micro-particles, 1.5 to 10 µm in diameter, or a monolithic rod	Alltima C18 Alltima C18-LL Alltima HP C18 Alltima HP C18-EPS Alltima HP C18-AQ Alltima HP C18-Amide Alltima HP C18-HiLoad Apex ODS Apollo C18 Genesis AQ Genesis C18 Prevail C18 Prevail C18-Select Vydac 218TP Vydac 238TP Vydac 201TP Vydac 202TP Vydac 218MS Vydac 238MS Vydac Denali 238DE Vydac Everest 238EV
L3	Porous silica particles, 1.5 to 10 µm in diameter, or a monolithic silica rod	Alltima Silica Alltima HP Silica Alltima HP HILIC Apex Silica Apollo Silica Genesis Silica Prevail Silica
L7	Octylsilane chemically bonded to totally or superficially porous silica particles, 1.5 to 10 µm in diameter, or a monolithic silica rod	Alltima C8 Alltima HP C8 Apollo C8 Genesis C8 Genesis C8EC Prevail C8 Vydac 208TP Vydac 208MS
L8	An essentially monomolecular layer of aminopropylsilane chemically bonded to totally porous silica gel support, 1.5 to 10 µm in diameter, or a monolithic silica rod	Alltima Amino Apex II Amino Prevail Amino
L10	Nitrile groups chemically bonded to porous silica particles, 1.5 to 10 µm in diameter, or a monolithic silica rod	Alltima Cyano Alltima HP Cyano Genesis Cyano Prevail Cyano
L11	Phenyl groups chemically bonded to porous silica particles, 1.5 to 10 µm in diameter, or a monolithic silica rod	Alltima Phenyl Apollo Phenyl Genesis Phenyl Prevail Phenyl Vydac 219TP
L17	Strong cation-exchange resin consisting of sulfonated cross-linked styrene-divinylbenzene copolymer in the hydrogen form, 6 to 12 µm in diameter	Organic Acid OA-1000 Organic Acid OA-2000 Organic Acid IOA-1000 Organic Acid IOA-2000
L19	Strong cation-exchange resin consisting of sulfonated cross-linked styrene-divinylbenzene copolymer in the calcium form, 5 – 15 µm in diameter	Carbohydrate Cation
L22	A cation-exchange resin made of porous polystyrene gel with sulfonic acid groups, 5 – 15 µm in diameter	Anion Exclusion
L23	An anion-exchange resin made of porous polymethacrylate or polyacrylate gel with quaternary ammonium groups, 7 - 12 µm in diameter	Allsep Anion
L26	Butyl silane chemically bonded to totally porous or superficially porous silica particles, 1.5 to 10 µm in diameter	Vydac 214TP Vydac 214ATP Vydac 214MS



Alltima

The Alltima HPLC column range was developed by Alltech. Hichrom acquired the entire range from Grace. Alltima phases are acid and base-deactivated, giving excellent peak shape for acids, bases, and neutrals in a single run. Polymerically bonded and double-encapped for long column lifetimes, Alltima columns are great general purpose “workhorse” columns.

Key Features

- Base deactivated silica
- Stable bonding for long column lifetime
- Symmetrical peak shape

Alltima Phase Specifications

Phase	Particle size / μm	Endcapped?	Properties	Applications	USP Code
C18	3, 5, 10	Yes	Classic reversed-phase retention and selectivity	High quality hydrophobic general purpose C18	L1
C18-LL	5	Yes	Lower carbon load than traditional Alltima C18	Reversed-phase applications that require a less hydrophobic C18 phase	L1
C8	3, 5	Yes	Lower retention compared to C18 phases	Reversed-phase applications where C18 is too retentive	L7
Amino	3, 5	No	General purpose amino suitable for normal or reversed-phase use	Use for carbohydrate analysis or as a weak anion exchanger	L8
Cyano	3, 5	Yes	General purpose cyano suitable for normal or reversed-phase use	Rugged normal-phase applications	L10
Phenyl	3, 5	Yes	Less hydrophobic than C18 phase	Selective to aromatic compounds	L11
Silica	3, 5, 10	-	Highly polar phase	General purpose normal phase applications	L3



Alltima HP

The Alltima HP range of HPLC columns was developed by Alltech. Hichrom acquired this range from Grace. Alltima HP columns offer a range of different phase chemistries based on high purity silica. The Alltima HP product family combines the selectivity and performance needed to overcome the most challenging separation needs. The low column bleed makes these columns ideal for microbore applications.

Key Features

- High purity silica
- Excellent column stability
- Low to no detectable column bleed
- pH stability from 1 to 10
- Multiple selectivity options

Alltima HP Phase Specifications

Phase	Particle size / μm	Endcapped?	Properties	Applications	USP code
C18	3, 5	Yes	Classic reversed-phase retention and selectivity	Routine applications	L1
C18-EPS	3, 5	Yes	Greater retention and enhanced peak symmetry for polar compounds. Alternative selectivity to traditional reversed-phase	Reversed-phase applications where C18 is too retentive	L1
C18-HiLoad	3, 5	Yes	Highest carbon load for superior retention and loadability	High resolution for complex samples	L1
C18-AQ	3, 5	Yes	100% water wettable	Applications requiring high aqueous mobile phases	L1
C18-Amide	3, 5	Yes	Polar-embedded phase with extremely low bleed. Compatible with microbore	Basic compounds in neutral to alkaline pH, MS applications	L1
C8	3, 5	Yes	Lower retention compared to C18 phases	Reversed-phase applications where C18 is too retentive	L7
Cyano	3, 5	Yes	Extremely stable, long life and reproducible	Ideal for basic drug analysis	L10
Silica	3, 5	No	Highly polar phase	General purpose normal phase applications	L3
HILIC	3, 5	—	Hydrophilic Interaction Chromatography uses small amounts of water for increased sensitivity with microbore applications	Very polar analytes that are difficult to retain by reversed-phase	L3



Apex

Apex was originally developed by Jones Chromatography. This range was acquired by Hichrom from Grace. Apex are an economical range of columns manufactured using traditional silica. These columns are recommended for routine analysis and legacy methods.

Key Features

- Conventional 100 Å pore size spherical silica
- Narrow particle size distribution
- Controlled surface area

Apex and Apex II Specifications

Phase	Particle size / μm	Endcapped?	USP code
Apex ODS	5, 10	Yes	L1
Apex Silica	3, 5	—	L3
Apex II Amino	3	No	L8



Apollo

Originally an Alltech brand, Hichrom acquired the Apollo range of HPLC columns from Grace. Apollo HPLC columns are based on high purity, base deactivated silica for powerful separations at an economical price. They are ideal for routine analysis in educational laboratories.

Key Features

- Easy scale-up from analytical to prep
- Extended pH stability – 1.5 to 10.5

Apollo Phase Specifications

Phase	Particle size / μm	Endcapped?	USP code
C18	5	Yes	L1
C8	5	Yes	L7
Phenyl	5	Yes	L11
Silica	5	—	L3





Genesis

Genesis HPLC columns were developed by Jones Chromatography. Hichrom acquired this range of columns from Grace. Genesis phases are based on high purity, metal-free, spherical silica. They are suitable for the analysis of a wide range of compounds.

Key Features

- Good peak shape and reproducibility
- Long column lifetime
- pH stability 1 to 10

Genesis Phase Specifications

Phase	Particle size / μm	Endcapped?	Properties	USP code
C18	3, 4, 5	Yes	Excellent peak symmetry. Reduced need for mobile phase modifiers. Long column life.	L1
C8	4, 5	No	Suitable for lower pH separations.	L7
C8(EC)	4	Yes	Excellent peak symmetry. Reduced need for mobile phase modifiers. Long column life.	L7
AQ	4	Yes	Designed for separating hydrophilic and polar compounds. Stable retention times in 100 % aqueous mobile phases. Rapid equilibration. Unique reversed-phase selectivity.	L1
Phenyl	4, 5	Yes	Reversed-phase chemistry. Improves the chromatography of polar aromatics, fatty acids, and basic pharmaceuticals.	L11
Cyano	4	Yes	Suitable for polar analysis, analytes with double- and/or triple-bonds, and compounds that have too much retention on alkyl phases.	L10
Silica	4	—	Highly polar phase for general purpose applications.	L3



Prevail

The Prevail range of HPLC columns were developed by Alltech. Hichrom acquired this range from Grace. The Prevail range exhibits long lifetimes in both highly aqueous and highly organic mobile phases. The stability of these phases is such that a single column can be switched between highly aqueous, for analysis of highly polar analytes, and highly organic, for strong retention of hydrophobic analytes.

Key Features

- Stable from highly organic to highly aqueous
- Speciality phases for specific applications
- Excellent sensitivity with microbore and ELSD applications

Prevail Phase Specifications

Phase	Particle size / μm	Properties	Applications	USP code
C18	3, 5	Stable in highly aqueous to highly organic mobile phases	Flexibility to switch between varied mobile phase conditions to suit a variety of applications. Excellent sensitivity for microbore applications	L1
C18-Select	3, 5	Stable in highly aqueous to highly organic mobile phases	Suitable for applications where greater retention than the Prevail C18 is required	L1
C8	5	Stable C8 phase	Use for highly hydrophobic compounds that retain too strongly on C18	L7
Phenyl	5	Lowest hydrophobic capacity	Selective for aromatic compounds in a variety of mobile phase conditions	L11
Cyano	3, 5	General purpose cyano suitable for normal or reversed-phase use	Rugged normal phase applications	L10
Amino	3, 5	Stable in highly aqueous to highly organic mobile phases	Use for carbohydrates or as a weak anion exchanger	L8
Amide	5	Polar embedded phase	Suitable for use with highly aqueous mobile phases	—
Silica	3, 5	Highly polar phase	General purpose normal phase applications	L3
Organic acid	3, 5	Highly efficient silica-based, acid-stable phase	Separates common organic acids with unsurpassed resolution, speed and sensitivity. Lower cost than polymeric columns	—

Prevail Organic Acid

Prevail Organic Acid columns are silica-based for maximum efficiency and high resolution. They can separate common organic acids with a combination of speed, sensitivity, and simplicity. A simple acidic phosphate buffer and a Prevail OA column at ambient temperature will separate 11 short chain organic acids in less than 6 minutes. The retention profile can be readily adjusted by changing the mobile phase pH.



Ion Chromatography

Allsep Anion

The Allsep Anion column range was developed by Alltech. Hichrom acquired this column range from Grace. Allsep Anion is a methacrylate-based phase with quaternary ammonium functional groups, optimised for use with both suppressed and non-suppressed conductivity detection. Columns are compatible with common IC mobile phases, such as carbonate, bicarbonate, p-hydroxybenzoic acid, phthalic acid, succinic acid, and sodium octane sulfonate.

Allsep Anion is recommended for applications involving inorganic anions, weak and strong acid ions, metal complexes and organic acids. It meets the requirements for the EPA method 300.0 Part A for determination of inorganic ions in water.

Key Features

- 7 µm polymer-based anion exchange phase
- Suppressed or non-suppressed conductivity detection
- pH range 2–10
- Use with 0–100 % organic modifier
- USP L23

Hichrom Organic Acid

Hichrom Organic Acid columns are ion exclusion columns packed with sulphonated polystyrene-divinylbenzene. The OA-1000 and OA-2000 columns exhibit excellent selectivity for aliphatic and aromatic acids. As with most ion exclusion columns, a column heater is necessary for normal operating procedures.

The IOA-1000 and IOA-2000 columns are suitable for the separation of citric and other acids from glucose and fructose.

Key Features

- Rapid analysis of organic acids and alcohols
- pH stable polymer resin
- Isocratic 100 % aqueous mobile phases only - no organic solvents
- USP L17

Hichrom Anion Exclusion

Hichrom Anion Exclusion columns are based on a highly sulphonated polystyrene-divinylbenzene cation-exchange resin. The phase has a particle size of 10 µm and is designed for the separation of organic acids and weakly ionised anions by an anion exclusion mechanism. Typical mobile phases contain dilute mineral acids. Acetonitrile (<10%) may be added as organic modifier to decrease the retention of hydrophobic compounds.

Key Features

- Separates organic acids and weakly ionised anions
- Polymer-based for broad pH stability
- USP L22

Hichrom Anion/S

Hichrom Anion/S columns are based on 10 µm silica with quaternary ammonium ion-exchange groups. These columns are optimised for non-suppressed conductivity detection and are best suited for routine separations of chloride, bromide, nitrate, and sulphate.

Key Features

- Silica-based for symmetrical peak shapes
- Separates inorganic and organic anions

Hichrom Carbohydrate Cation

The Hichrom Carbohydrate Cation column consists of a highly efficient sulphonated polystyrene resin supplied in the calcium form. This column provides excellent separations using only water as the mobile phase.

Key Features

- Sulphonated polystyrene resin (Ca²⁺ form)
- 100% water used as mobile phase
- Column heating required
- USP L19



Vydac

Vydac 300 Å columns are a commonly employed range in bioseparations. Following the acquisition of Grace HPLC ranges by Hichrom, Vydac columns continue to be available exclusively from Hichrom in capillary to microbore and analytical to preparative dimensions.

Separate biomolecules from small peptides to large intact proteins with the Vydac family of reversed-phase columns (including Vydac TP, MS, Denali, and Everest) and ion exchange (Vydac 3021C) columns. Reversed-phase columns for a polypeptide separation should be considered on the basis of the polypeptide's hydrophobicity, with molecular weight as a secondary consideration.

Vydac TP

Vydac TP reversed-phase material consists of aliphatic groups bonded to the surface of 300 Å pore diameter silica. The large pores of the TP silica give polypeptide molecules complete access to the interior of the silica pores. Vydac TP silica is the standard that has defined large pore HPLC for polypeptide separations for nearly two decades.

Key Features

- Long column lifetime and negligible phase leaching
- Reliable protein purifications, scalable from analytical to preparative scale
- Referenced in a large number of patents and publications

Vydac TP Phase Specifications

Phase	Functional group	Particle size / μm	Properties	Applications	USP code
218TP	C18	3, 5, 10	First generation polymeric C18 phase with unique selectivity	Small polypeptides 4-5 kDa MW, enzymatic digest fragments, natural and synthetic peptides, multi-ring compounds	L1
238TP	C18	5	First generation monomeric C18 phase	Use for same applications as 218TP, but offers different C18 selectivity	L1
201TP	C18	5, 10	Non-encapped C18 phase	Developed for separation of PAHs	L1
202TP	C18	5	Higher carbon load than 201TP	Developed for separation of PAHs	L1
208TP	C8	3, 5, 10	Less hydrophobic than C18TP phase	Polypeptides 10-20 kDa MW	L7
214TP	C4	5, 10	First generation C4 phase	Glycoproteins, haemoglobin variants, histones, insulin variants, membrane proteins	L26
214ATP	C4	5	C4 phase with lower level of endcapping	Optimised for analysis of human growth hormone	L26
219TP	Diphenyl	5, 10	Lowest capacity first generation diphenyl phase	Polypeptides with aromatic side chains, large hydrophobic proteins, membrane-spanning peptides, lipid peptides, fusion proteins from inclusion bodies	L11



Vydac MS

Vydac MS is a further development of the Vydac range for reversed-phase separation of biomolecules. A proprietary surface treatment and bonding process give Vydac MS columns unique selectivity. A variety of reversed-phases makes this product line suitable for the analysis of small peptides to large intact proteins.

Key Features

- 300 Å pore size spherical silica
- Four reversed-phase chemistries
- Excellent peak shape with little or no TFA
- High protein recoveries make scale-up easy

Vydac MS Phase Specifications

Phase	Functional group	Particle size / μm	Properties	Applications	USP code
218MS	C18	5, 10	Polymeric bonding, highest hydrophobic interaction and unique geometric selectivity	Use for simple enzymatic digests (<12 proteins) or biomolecules 0–5 kDa MW	L1
238MS	C18	5	Monomeric bonding offers increased peptide interaction and generally yields higher peak counts	Use for same applications as 218MS, but offers different C18 selectivity	L1
208MS	C8	5, 10	Lower hydrophobicity is better for larger biomolecules	Ideal for biomolecules 5–10 kDa MW	L7
214MS	C4	5, 10	Lower capacity than C18 or C8, suitable for hydrophobic proteins or when minimal organic solvent is desired	Ideal for biomolecules >10 kDa MW, intact proteins, antibodies, oligonucleotides, human growth hormone	L26

Vydac Everest

Everest columns (238EV) have unique selectivity and sensitivity, which are the result of bonding technology that improves C18 surface coverage and deactivates residual silanols. Leading 300 Å C18 chemistries have had carbon coverage in the 2.8 to 3.6 $\mu\text{mol m}^{-2}$ range. Everest C18 coverage is in excess of 4 $\mu\text{mol m}^{-2}$ and approximates the theoretical limit based on surface area. The increased shielding of the base silica increases column lifetime and reduces the amount of TFA required to shield the silica.

Key Features

- Unique selectivity for hydrophilic and hydrophobic peptides
- 300 Å pore size spherical silica
- Excellent sensitivity with little or no TFA in mobile phase
- Ideal for complex enzymatic digests (>12 proteins)

Vydac Denali

Vydac Denali (238DE) is a 120 Å C18 bonded phase with high carbon coverage, suitable for the analysis of both acidic and basic analytes. It has applications for small molecule analyses of interest to pharmaceutical and environmental laboratories.

Key Features

- High retentiveness
- LC/MS of small molecules
- Fully scalable from capillary to process



Partisil & Partisphere

Key Features

- Choice of spherical or irregular silica
- Wide range of surface chemistries

Partisil[®] and Partisphere[®] Acquisition

Hichrom acquired the Partisil and Partisphere HPLC column range from Whatman, a division of GE Healthcare, in 2012. Hichrom worked closely with GE Healthcare during the manufacture of these products for a number of years prior to acquisition and, as such, manufacturing protocols, product specifications and part numbers remain unaffected. All column dimensions previously offered by Whatman/GE Healthcare remain available and are detailed on the following pages.

Hichrom Partisil Columns – Non Standard Whatman/GE Healthcare Dimensions

Hichrom have a deserved reputation for the ability to manufacture and supply high efficiency columns packed into non standard dimensions not originally offered by the silica manufacturer. Partisil columns are no exception, as for many years Hichrom have manufactured Partisil columns into a wider range of column dimensions than available from Whatman/GE Healthcare. These additional dimensions will continue to be supported following the acquisition.

Partisil Phases

- Irregular porous silica
- 5 and 10µm particle sizes
- Hichrom high efficiency

Partisil was one of the first commercially available irregular silicas. A large surface area gives it a high loading capacity. Partisil ion-exchange materials are widely referenced and remain one of the most popular choices for analysts. Partisil 10 ODS3 is similar to Waters µBondapak.

Partisil Phase	Functional Group	Particle Size (µm)
Silica	-	5, 10
C8	Octyl	5, 10
ODS	Octadecyl	10
ODS2	Octadecyl	10
ODS3	Octadecyl	5, 10
PAC	Amino-cyano	5, 10
SAX	Tetramethyl ammonium	5, 10
SCX	Sulphonic acid	5, 10

Partisil ODS is a low carbon load C18 phase, with intentionally unbonded surface silanols adding to the selectivity.

Partisil ODS2 is a high carbon load C18 bonded silica phase which makes it the most non-polar and, therefore, the most retentive of the Partisil reversed-phase columns. The high sample load capacity is suitable for preparative work.

Partisil ODS3 is an intermediate carbon load C18 phase used for pharmaceutical, natural products, food, biological and environmental pollutants applications. Partisil 10 ODS3 is similar to Waters µBondapak.

Partisil C8 is recommended for ion-pair chromatography.

Partisil PAC is a Polar Amino Cyano bonded phase with secondary amine groups for good thermal and chemical stability. Fast equilibration enables multiple separation mechanisms, including adsorption, reversed-phase and weak anion-exchange, to be used. The phase is particularly suitable for carbohydrate separations.

Partisil SAX is a strong anion-exchange phase based on quaternary ammonium groups. It is stable over the pH range 1.5 to 7.5. At intermediate pH, use of a Solvecon eluent conditioning column (see part number 4250-001) is recommended to further enhance column lifetime. Typical applications include nucleic acids, organic acids and inorganic anions.

Partisil SCX is a strong cation-exchange phase based on benzenesulphonic acid groups and is stable over the pH range 1.5 to 7.0. At intermediate pH, use of a Solvecon eluent conditioning column (see part number 4251-001) is recommended to further enhance column lifetime. Suitable applications include nucleosides, amino acids, polyamines, drugs and other cationic species.

Partisphere Phases

- Spherical 5µm porous silica
- Unique void sealing cartridge hardware
- Convenient and easy to use – hand tightened fittings
- Increased column lifetime

Partisphere was one of the first commercially available spherical silicas and continues to provide reproducible, high efficiency separations. Partisphere columns are available in a wide range of surface chemistries, including two application specific phases: TAC-1 (Taxane Analysis Column) for the analysis of paclitaxel and other taxanes, and WAX (MAX-1) for corn and soy protein.

Partisphere Phase	Functional Group	Particle Size (µm)
Silica	-	5
C8	Octyl	5
C18	Octadecyl	5
PAC	Amino-cyano	5
SAX	Quaternary ammonium	5
SCX	Sulphonic acid	5
TAC-1 (PFP)	Pentafluorophenyl	5
WAX (MAX-1)	Proprietary	5

Unique Void-sealing Cartridge System

Partisphere columns are available in a unique void sealing (WVS) hardware. If a void eventually forms at the top of the column bed, a simple hand tightening of the inlet fitting moves the frit assembly downwards and recompresses the packed bed, thus removing the void and restoring column efficiency. Large knurled end fittings allow ready hand tightening of the system. All WVS cartridge columns are shipped without end fittings and require end fitting kit, catalogue no. 4631-1001. This item can be interchanged with additional WVS columns.

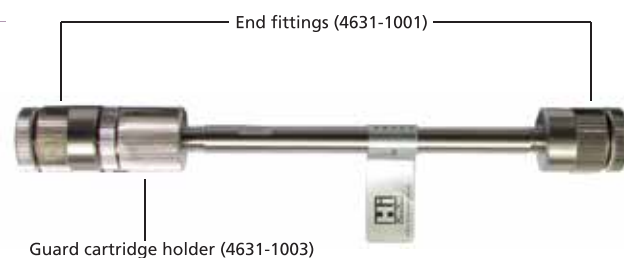

Figure 1. Partisphere WVS hardware cartridge system

Partisphere Guard Cartridge System

Additional installation of the unique WVS guard cartridge holder (catalogue no. 4631-1003) allows the use of guard cartridges (see Figure 1).



Ultrasphere®

- Acquired by Hichrom from Beckman Coulter
- High reproducibility
- Optimal surface coverage for long column lifetime
- Narrow particle size distribution for high efficiency and improved resolution
- Widely referenced silica

Ultrasphere Phase	Particle Size (µm)	Pore Size (Å)	Endcapped
ODS (C18)	3, 5	80	Yes
Octyl (C8)	3, 5	80	Yes
Cyano (CN)	3, 5	80	No
Silica (Si)	3, 5	80	n/a
Ion Pair (IP)	5	80	Yes

Ultrasphere columns are available in five phases with a 5µm particle size – ODS (C18), Octyl (C8), Cyano (CN), Ion Pair (IP) and unbonded silica (Si). Additionally, ODS, Octyl, Cyano and unbonded silica chemistries are available with a 3µm particle size.

Ultrasphere columns remain widely referenced within both industry and academia and are recognised to provide excellent chromatographic performance.

Columns are available in a wide range of dimensions, including microbore (2.0mm i.d.), analytical (4.6mm i.d.) and semi-preparative (10mm i.d.) options. Please contact Hichrom to request availability of any column dimension not listed.



Heliflex™ AT™ - +

Econo-Cap™ EC™ - +

GC columns

MEGA is the exclusive authorized licensee of the Heliflex™ and Econo-Cap™ GC columns and will continue to produce* the "AT™ -" ed "EC™ -" GC columns (for example AT™-624+ o EC™-WAX+) in order to supply you with Heliflex™ and Econo-Cap™ GC columns fully equivalent to those you've always used until now. You can find the entire catalog of the Heliflex™ and Econo-Cap™ GC columns on MEGA website (www.mega.mi.it) and also on our exclusive and official partner for India, Apex Chromatography Pvt. Ltd., website here:

www.apexchromatography.com



Apex Chromatography Pvt. Ltd.

The complete solution for all your analytical needs

*: produced by MEGA (Legnano (MI) - Italy)
under W. R. Grace & Co. -Conn. (GRACE)
and Alltech Associates, Inc. exclusive License

by

MEGA®

improve your GC analysis

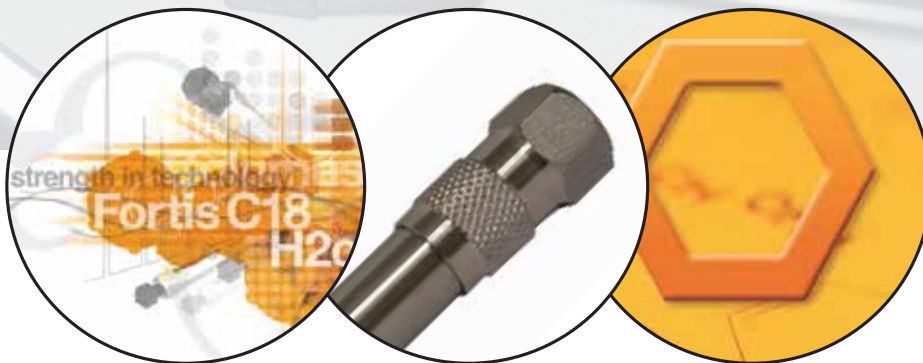

Fortis Technologies was established in 2005 to provide novel products and add value to the HPLC and UHPLC columns market. Fortis Technologies was founded by directors with over 20 year experience extensively within the silica manufacturing and HPLC Columns industry.

FortisTM C18

- Operate at low, mid and high pH
- Superb peak shape, efficiency & resolution

FortisTM H2o

- Polar analyte retention
- 100% Aqueous usage

FortisTM Phenyl

- Unique di-phenyl character
- Separate positional isomers

FortisTM HILIC

- Increased MS Sensitivity, with reduced Extraction (SPE) & Dry Down times

FortisTM Cyano

- Alternate Selectivity for Normal and Reversed Phase System

FortisTM C8



- Lower hydrophobicity
- Great peak shape, efficiency and resolution

FortisTM Pace

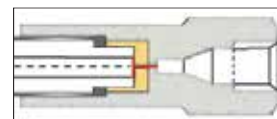
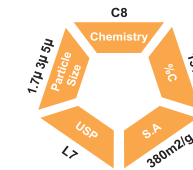
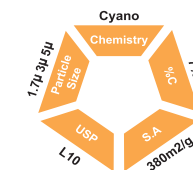
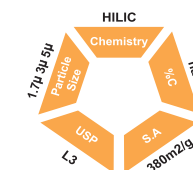
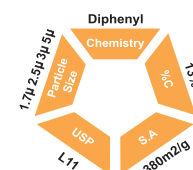
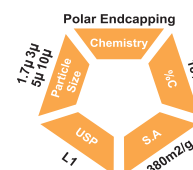
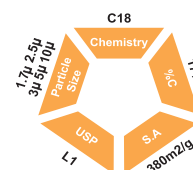
- Optimised for High Throughput Screening (HTS)
- LC-MS Optimised

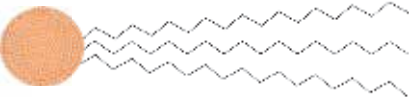
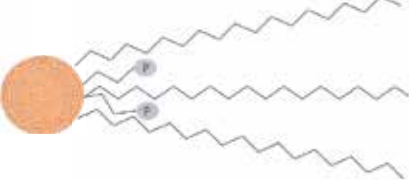

Fortis Phase Chemistry Selectivity

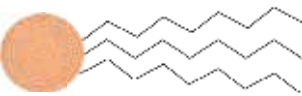
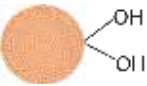
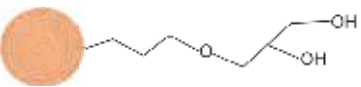
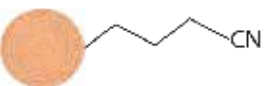
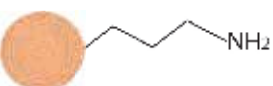
	<p>Fortis C18</p> <ul style="list-style-type: none"> - General UHPLC use - Method Development from pH 1-12 	<p>Acids Bases Neutrals</p>
	<p>Fortis H20</p> <ul style="list-style-type: none"> - Polar endcapped - Increased polar retention 	<p>Hydrophilic analytes Organic acids Catecholamines</p>
	<p>Fortis Diphenyl</p> <ul style="list-style-type: none"> - Unique di-phenyl structure - Metabolite profiling - Separate positional isomers 	<p>Metabolites Positional Isomers Hydrophilic / Hydrophobic analytes</p>
	<p>Fortis C8</p> <ul style="list-style-type: none"> - General UHPLC use - Method Development 	<p>Lipids Steroids Highly Hydrophobic analytes</p>
	<p>Fortis HILIC</p> <ul style="list-style-type: none"> - High polar retention - Homogenous silanol concentration - Improve MS sensitivity 	<p>Carboxylic acids Nucleotides Vitamins</p>
	<p>Fortis HILIC Diol</p> <ul style="list-style-type: none"> - Alternate selectivity to bare silica - Stable bonding - HILIC or Normal phase mode 	<p>Steroids Proteins Metabolites</p>
	<p>Fortis Cyano</p> <ul style="list-style-type: none"> - Cyano functionality - Reversed phase or Normal phase 	<p>Explosives Pesticides Steroids</p>
	<p>Fortis Amino</p> <ul style="list-style-type: none"> - Reproducible, Robust bonding - Reversed phase, Normal phase or Ion exchange mode 	<p>Saccharides Oligonucleotides Steroids</p>



Fortis Method Development Options

- Choice of Stationary phase functionality
- Based on Ultra pure silica
- Reversed Phase (RP) and Normal Phase (NP) options

Method Dev

Fortis® H2o

- Polar endcapped C18
- Increased polar retention
- *Organic acids*
- *Catecholamines*

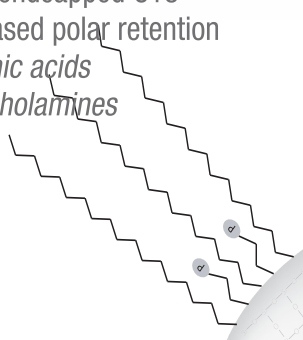

Fortis® Diphenyl

- Unique di-phenyl structure
- Separate Positional Isomers
- Metabolite profiling

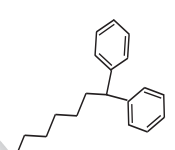

Fortis® HILIC

- High Polar Retention
- Highly Pure Silica
- *Carboxylic acids*
- *Nucleotides*

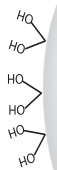

Fortis® C18

- General HPLC use
- Method dev. from pH 1-12
- Acids, Bases and Neutral



Fortis® HILIC DIOL

- High Polar Retention
- Highly Pure Silica
- *Nucleotides*

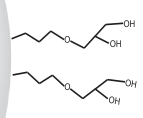

Fortis® Cyano

- Cyano functionality
- RP or NP use
- *Explosives*
- *Pesticides*

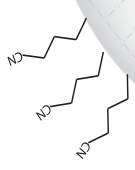

Fortis® C8

- Reduced Hydrophobicity
- *Lipids*
- *Steroids*

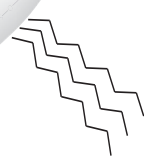

Fortis® Amino

- High Polar Retention
- Highly Pure Silica
- *Carbohydrates*

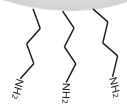

Getting Started :

Method development typically starts with a C18 or C8 column, both provide Hydrophobic retention with good peak shapes for neutral, acidic and basic analytes. Generally if retention of polar molecules is also needed then a polar endcapped stationary phase such as Fortis H2o is a good starting choice.

If selectivity is insufficient then Diphenyl or Cyano stationary phases are a good alternative, they will change selectivity and even elution order since they work on dipole characteristics as opposed to just hydrophobicity.

Fortis Cyano is good in normal phase (NP) conditions for polar analytes with COOH, NH₂, NHR₂ or NR₂ groups. If small polar molecules still do not retain then HILIC chromatography is a suitable alternative.

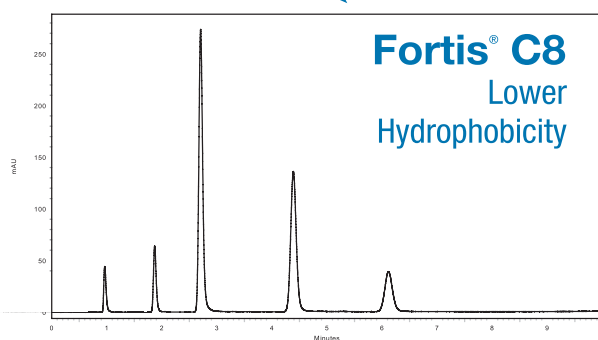
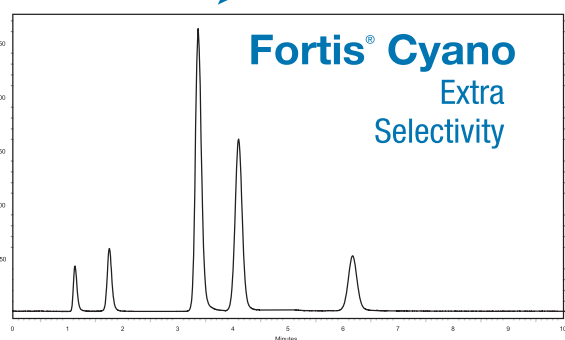
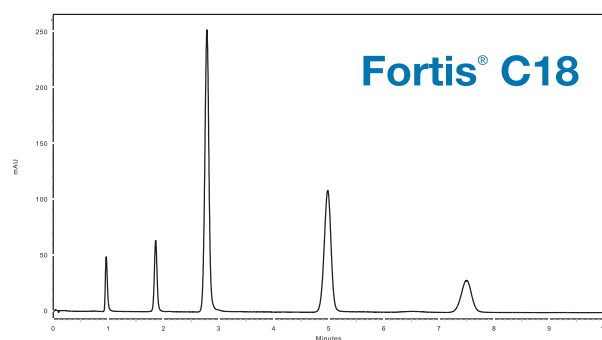
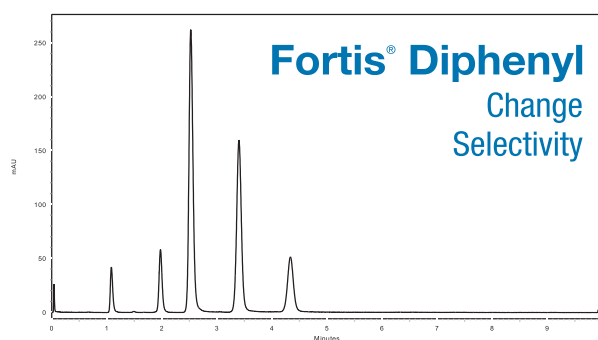
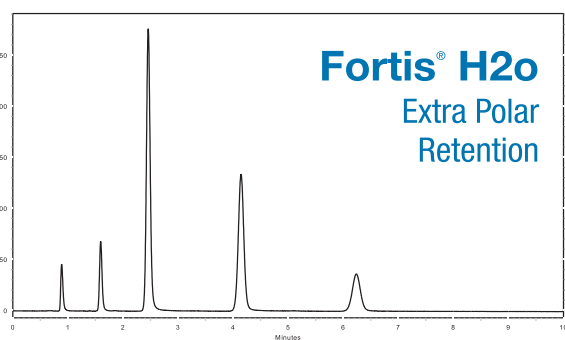

Acidic, Neutral & basic analytes

- Fortis C18
- Fortis C8
- Fortis Diphenyl

Polar basic molecules

- Fortis C18 operated at high pH
- Fortis Diphenyl
- Fortis H2o

Polar acidic molecules

- Fortis H2o
- Fortis HILIC
- Fortis Cyano in NP mode

Alternate Selectivity

- Fortis Diphenyl
- Fortis Cyano



Fortis[®] SpeedCore[®]

Fortis Speedcore[®] columns are the very latest in core-shell technology. Incorporating our optimised bonding and packing practices with a core-shell particle provides the analyst with the ability to speed up analysis and increase resolution over 'traditional' 3 μ & 5 μ particles even on normal 400bar systems.

Now includes new, extended pH



Fortis[®] SpeedCore[®] pH+ C18

New Peptide and Protein options



Fortis[®] SpeedCore[®] BIO

	Particle Size	Surface Area	Pore Size	% C	pH range	USP
SpeedCore C18	2.6 μ m and 5 μ m	140m ² /g	80Å	10	1-9	L1
SpeedCore pH+ C18	2.6 μ m and 5 μ m	140m ² /g	80Å	11	2-11	L1
SpeedCore RP18-Amide	2.6 μ m and 5 μ m	140m ² /g	80Å	9	2-9	L60
SpeedCore Diphenyl	2.6 μ m and 5 μ m	140m ² /g	80Å	7	2-9	L11
SpeedCore PFP	2.6 μ m and 5 μ m	140m ² /g	80Å	6	2-9	L43
SpeedCore HILIC	2.6 μ m and 5 μ m	140m ² /g	80Å	N/A	2-8	L3

	Particle Size	Surface Area	Pore Size	% C	pH range	USP
SpeedCore BIO Peptide C18	2.6 μ m	-	160Å	6	1-8	L1
SpeedCore BIO Protein C18	3.5 μ m	-	300Å	4	1-8	L1
SpeedCore BIO Protein C8	3.5 μ m	-	300Å	3	1-8	L7
SpeedCore BIO Protein C4	3.5 μ m	-	300Å	2	1-8	L26

Stationary Phase Choice



- **C18 Hydrophobicity**
- **Ultra High Efficiency**
- **Method development starting point**

SpeedCore C18 is designed to provide characteristics which will enhance method development. It provides the ability to obtain sharp peak shapes whilst retaining and separating a wide variety of compounds both hydrophobic and hydrophilic.



- **Increased high pH range**
- **Optimal peak shape and retention for bases**
- **Combined with Ultra High Efficiency particles**

SpeedCore pH Plus is designed to provide increased high pH stability. Excellent peak shape for basic analytes if they can be neutralised at higher pH values. Increase loading capacity for bases at high pH.



- **Orthogonal Selectivity**
- **Sharp peak shapes for basic analytes**
- **Excellent method development option**

SpeedCore RP18-Amide is designed to provide polar characteristics which will enhance resolution in method development. It provides orthogonal selectivity to alkyl chain phases due to its polar-embedded group. Sharp peak shapes, extra selectivity and retention can all be obtained.



- **Alternative selectivity**
- **Separate positional isomers**
- **Stable ligand, No "MS" bleed**

SpeedCore Diphenyl is designed to provide pi-pi, steric and hydrophobic characteristics which will enhance selectivity and the ability to develop methods. Particularly suited to positional isomers and other closely related species such as metabolites.



- **Reversed phase selectivity**
- **Separate metabolites**
- **Excellent resolution**

SpeedCore PFP (PentaFluoroPhenyl) is designed to provide characteristics which will enhance selectivity. It provides alternate selectivity to a hydrophobic stationary phase whilst still maintaining the key attributes of robustness and reproducibility.



- **Hydrophilic Interaction Mode**
- **Separate polar species**
- **Excellent stability**

SpeedCore HILIC is designed to provide characteristics which will enhance retention of highly polar analytes. Reproducible surface characteristics provide robust separations.



Take Control

IQ/OQ/PQ Kits, Tools and Software
for Analytical Instrument Qualification

VKIT-LFM2 HPLC liquid flowmeter

VKIT-LFM2 HPLC liquid flowmeter

Specially designed for HPLC and UPLC, the V:Kit liquid flowmeter enables easy and accurate measurement of flow rates. The tripod mount and robust carry case make VKIT-LFM2, the perfect tool for field service engineers and laboratory personnel performing OQ/PQ and routine performance verification activities.

The V:Kit HPLC liquid flowmeter displays the current flow rate in ml/min to four decimal places. A USB port is provided for connection to a PC or serial printer, enabling compliance with the data integrity demands required in GxP environments.

Using the HPLC liquid flowmeter with the optional AutoFlow software or printer enables unattended operation: particularly useful when measuring the low flow rates associated with LCMS.

The flowmeter makes possible simpler diagnosis of common HPLC pump problems such as poorly functioning check valves or leaking pump seals.

LFM2 improves on the classic, well-proven VKIT-LFM design by adding faster response time, greater accuracy at low flow rates, a more compact design and improved connectivity via USB.

HPLC flowmeter specifications

- 0.05 to 9.99ml/min flow range
- 1µl/min resolution
- Multi-point calibration with UKAS (UK equivalent of NIST) traceability calibration certificate
- PTFE, PEEK, FEP & ACETAL wetted parts
- 195µl sensor volume: 5 readings each minute at 1.00ml/min.
- 24V DC UK (3pin UK 240V), EU (2-pin 220V) or USA (2-pin 120V) (state when ordering)
- Backlit LCD display
- Weight: 1.8kg
- Dimensions: 132mm x 89mm x 64mm (HxWxD)
- Integrated tripod stand allows easy positioning on the bench
- Supplied with sturdy carrying case



Integrated tripod stand



Carry case

About V:Kit

V:Kit specialise in delivering solutions for Analytical Instrument Qualification. With a comprehensive range of measuring tools, software, protocols, standard operating procedures and certified standards, V:Kit products are used by OEMs, service providers and pharmaceutical laboratories worldwide.

Take control of your qualification needs with V:Kit.

GLP / Data Integrity Options

To assist with GLP and the increasing demands for data integrity by regulatory agencies such as FDA, EMA and PMDA, the liquid flowmeter can be optionally specified with software or a dedicated printer.

VKIT-PRT Printer

The flowmeter may also be specified with a printer option, to provide simple, effective traceability.

VKIT-PRT This is connected via the USB port and provides a time and date stamp of each flow reading. No PC software is required, and the printer is encoded with the flowmeter serial number.



AutoFlow

AutoFlow is an optional software module. It is available as standalone (flowrate only) or as part of the V:Kit 5 Analytical Instrument Qualification package.

Flow data can be read directly from the flowmeter into V:Kit AutoFlow software to produce an audit-friendly and traceable calibration report which evaluates the flow accuracy and precision of your HPLC and UPLC equipment.

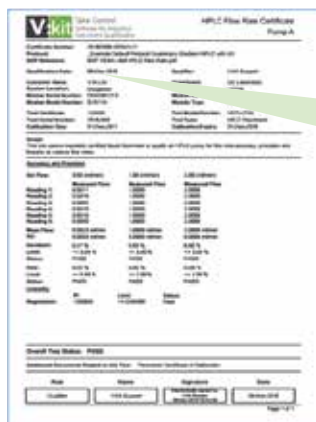

Typical Flowrate Report



VKIT-LFM2 HPLC liquid flowmeter

More about V:Kit 5.1 Software - Qualify your laboratory systems with a 21 CFR Part 11 compliant package

- Generate comprehensive qualification documents with full traceability,
- Create, manage, and distribute secure, version controlled executable qualification protocols directly linked to Standard Operating Procedures and Certificates of Analysis.
- Manage your Analytical Equipment database.
- Share qualification results and protocols with your team. User account management with password expiry and security roles.
- Electronic Signatures, Audit Trail, Deviation Reporting.

Available for HPLC/UPLC, GC/GCMS, LCMS and MS/MS, Dissolution and UV-Vis.

Ordering codes

VKIT-LFM2	V:Kit HPLC/UPLC flowmeter, with calibration certificate. (Specify your required number of calibration setpoints, 1,2,3 4 or 5. Power supply requirements UK, EU, US or other)
V5-2002	V:Kit HPLC AutoFlow Software Starter Bundle
V5-PRT	Printer for VKIT-LFM/LFM2 HPLC flowmeter



Take Control

IQ/OQ/PQ Kits, Tools and Software
for Analytical Instrument Qualification

VKIT-1531 2-Channel printing thermometer

VKIT-1531 2-Channel Printing thermometer

Ideal for use for HPLC and GC testing, the V:Kit 2-Channel Printing thermometer enables simple and accurate measurement of temperatures in chromatographic systems using a range of customised thermocouple probes.

Supplied in a robust carry case, the VKIT-1531 is the perfect tool for field service engineers and laboratory personnel performing OQ/PQ and other routine performance verification activities.

The built-in printer records temperature values and a time/date stamp providing simple, effective traceability. The output is to plain paper to assist with long-term storage of raw data.

Thermometer specifications

- **Range and Accuracy (Type K)**
-200-1370°C, +/- (0.1% rdg +0.7°C),
-328-2498°F, +/- (0.1% rdg +1.4°F)
- **Resolution: 0.1°C** (in range of -200-650°C)
- **Multi-point calibration** (0, 25, 50, 100, 250 & 400°C.) with calibration certificate
- **Backlit LCD display size: 30 x 51 mm**
- **Dual input** (for Type K, J, R, S, T and E thermocouples.)
- **Supplied with 2 x VKIT-1516 Type K TC probes**
- **Built-in printer using thermal paper rolls**
- **Dimensions: 182 x 72 x 30mm (L x W x D)**
- **Weight: 150g**
- **Battery 4 x 1.5V AA or equivalent**
- **Supplied with sturdy carry case**



Measure column compartment temperature with the supplied VKIT-1516 probes



Measure GC inlet temperature with the VKIT-1517 inlet probe

About V:Kit

V:Kit specialise in delivering solutions for Analytical Instrument Qualification. With a comprehensive range of measuring tools, software, protocols, standard operating procedures and certified standards, V:Kit products are used by OEMs, service providers and pharmaceutical laboratories worldwide.

Take control of your qualification needs with V:Kit.

Thermocouple Probes

VKIT-1531
2-Channel printing
thermometer

VKIT-1531 is supplied with VKIT-1516 - two general purpose Type K Thermocouple probes. These are useful for low temperature applications (2 – 90 °C) such as HPLC column compartments.

V:Kit has developed a range of specialised thermocouple probes to simplify the task of making accurate and reliable measurements.



HPLC Autosampler Probe

VKIT-1514 Autosampler/ Sample Manager Probe, has a Type K thermocouple mounted in a 2ml autosampler vial (12x32 mm) shaped body. The base of the vial has a stainless-steel base to ensure good contact with the sample compartment of an autosampler and high thermal mass for measurement stability.

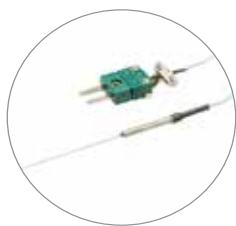

GC Inlet Temperature Probe

VKIT-1517 GC Inlet Probe has a Type K thermocouple mounted at the tip of 51mm needle. This allows temperature measurement of the inlet at precisely the position that the tip of a standard injection syringe would reach when injecting a sample. Most manufacturers split-splitless and packed inlets are compatible with this probe including Agilent, Shimadzu and PerkinElmer.



GC Column Probe

VKIT-1519 GC column oven probe has a 1.0 metre flexible stainless steel body with a Type K thermocouple mounted at the tip.

* Note thermocouple probes are supplied without calibration. To specify calibration add a RECAL-VKIT-151X part code to your order.

PC Software

The V:Kit tool range also includes an alternative thermometer, VKIT-DTM2 with optional PC software connectivity.

Temperature values are read directly from the thermometer into V:Kit AutoTemp software to produce an audit-friendly and traceable calibration report which evaluates the temperature accuracy and precision of your GC, HPLC and UPLC equipment.

More about V:Kit 5.1 Software - Qualify your laboratory systems with a 21 CFR Part 11 compliant package

- Generate comprehensive qualification documents with full traceability,
- Create, manage, and distribute secure, version controlled executable qualification protocols directly linked to Standard Operating Procedures and Certificates of Analysis.
- Manage your Analytical Equipment database.
- Share qualification results and protocols with your team. User account management with password expiry and security roles.
- Electronic Signatures, Audit Trail, Deviation Reporting.

Available for HPLC/UPLC, GC/GCMS, LCMS and MS/MS, Dissolution and UV-Vis.

Ordering codes

VKIT-1531	2-Channel Printing Thermometer with calibration certificate
VKIT-1514	HPLC autosampler tray probe
VKIT-1516	HPLC column oven temperature probe (x2)
VKIT-1517	GC inlet (split-splitless and packed) temperature probe
VKIT-1519	GC column oven temperature probe
V5-0011	AutoTemp Starter Bundle, includes software licence and USB cable



Take Control

IQ/OQ/PQ Kits, Tools and Software
for Analytical Instrument Qualification

VKIT-DTM2 2-Channel digital thermometer

VKIT-DTM2 2-Channel Digital thermometer

Ideal for use for HPLC and GC testing, VKIT-DTM2 is a 2-Channel digital thermometer which enables simple and accurate measurement of temperatures in chromatographic systems using a range of customised thermocouple probes.

Supplied with a certificate of calibration and in a robust carry case, VKIT-DTM2 is the perfect tool for field service engineers and laboratory personnel performing OQ/PQ and other routine performance verification activities. The unit's protective rubber boot includes a magnet (useful to attach the thermometer to metal GC oven doors) and a built-in stand.

Temperature values are displayed in units °C or °F, on a large LCD screen. A USB port is provided for connection to a PC, enabling compliance with the data integrity demands required in GxP environments.

Using VKIT-DTM2 with the optional AutoTemp software enables automated collection and reporting of temperature values: particularly useful when measuring the multiple zones found in GC or HPLC/UPLC systems.

DTM2 improves on the classic, proven VKIT-1531 design by adding a larger LCD display and improved connectivity via USB.

Thermometer specifications

- **Range and Accuracy (Type K)**
-200-1370°C, +/- (0.1% rdg +0.7°C),
-328-2498°F, +/- (0.1% rdg +1.4°F)
- **Resolution: 0.1°C (in range of -200-650°C)**
- **Multi-point calibration (0, 25, 50, 100, 250 & 400°C.) with calibration certificate**
- **Backlit LCD display size: 30 x 51 mm**
- **Dual input (for Type K, J, R, S, T and E thermocouples)**
- **Supplied with 2 x VKIT-1516 Type KTC probes**
- **Serial output to PC (requires optional cable)**
- **Dimensions: 182 x 72 x 30mm (L x W xD)**
- **Weight: 150g**
- **Battery 9V, PP9 or equivalent**
- **Protective rubber boot including stand and magnetic holder**



Simplifies testing of GC zones



VKIT-1517 inlet probe

About V:Kit

V:Kit specialise in delivering solutions for Analytical Instrument Qualification. With a comprehensive range of measuring tools, software, protocols, standard operating procedures and certified standards, V:Kit products are used by OEMs, service providers and pharmaceutical laboratories worldwide.

Take control of your qualification needs with V:Kit.



Take Control

IQ/OQ/PQ Kits, Tools and Software
for Analytical Instrument Qualification

VKIT-GFM3 Gas Flowmeter

VKIT-GFM3 Gas Flowmeter

Specifically designed for gas chromatography, VKIT-GFM3 enables simple and accurate measurement of gas flow in GC systems.

VKIT-GFM3 is the perfect tool for field service engineers and laboratory personnel performing OQ/PQ and other routine performance verification activities. It is supplied with a certificate of calibration.

Flow values are displayed in units of ml/min on a large LCD screen. A USB port is provided for connection to a PC, enabling compliance with the data integrity demands required in GxP environments.

VKIT-GFM3 improves on the classic, proven VKIT-GFM and the now obsolete ADM series flowmeter design by adding a larger LCD display, a re-chargeable Lithium ion battery and improved connectivity via USB.



Simplifies measurement
of GC flow zones

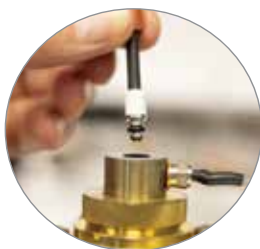

VKIT-1560 FID adaptor

Flowmeter specifications

- **Accuracy:** 0.4 ml/min or $\pm 2.5\%$ of the reading (whichever is greater)
- **Resolution:** 0.1ml/min
- **Range:** 0-500 ml/min (0-300 ml/min CO₂)
- **Inlet Pressure:** 25 psi (175kPa) maximum
- **Gases:** N₂, Air, He, H₂, CO₂, O₂, Ar, CH₄/Ar
- **Calibration:** Multi-point (0-400ml/min) with certificate of calibration
- **Display:** Backlit LCD
- **Serial output to PC (requires optional cable)**
- **Dimensions:** 68 x 130 x 30 mm
- **Weight:** 150g
- **Battery:** Re-chargeable Lithium ion, charging adaptor included or charge via micro-USB cable to PC
- **Modes:** Flow measurement, linear velocity and split ratio modes.

About V:Kit

V:Kit specialise in delivering solutions for Analytical Instrument Qualification. With a comprehensive range of measuring tools, software, protocols, standard operating procedures and certified standards, V:Kit products are used by OEMs, service providers and pharmaceutical laboratories worldwide.

Take control of your qualification needs with V:Kit.



Take Control

IQ/OQ/PQ Kits, Tools and Software
for Analytical Instrument Qualification

VKIT-DMA2 GC Pressure Meter

VKIT-DMA2 GC Pressure Meter

Specifically designed for gas chromatography, VKIT-DMA2 enables simple and accurate measurement of pressure in GC Inlets.

Measuring pressure accuracy and leak tightness is important. VKIT-DMA2 is the perfect tool for field service engineers and laboratory personnel performing OQ/PQ and other routine performance verification activities. It is supplied with an adaptor assembly allowing simple connection to GC inlets. The protective rubber boot includes a magnetic holder, for attaching the unit during use to the GC oven door.

Pressure Readings are displayed on a large, easy to read LCD in psi, kPa, kg/cm² and other units.

VKIT-DMA2 is supplied with a certificate of calibration. A USB port is provided for connection to a PC, enabling compliance with the data integrity demands required in GxP environments.

Using VKIT-DMA2 with the optional AutoPressure software enables automated collection and reporting of pressure values.

Pressure Meter specifications

- Accuracy $\leq 1.0\%$ of full scale at 25.0°C
- Resolution: 0.1psi
- Range: 0-100 psi
- Precision: $\leq 0.5\%$ of full scale
- Display units: psi, kPa, mmHg, kg/cm², mbar(hpa), bar, inH₂O, cmH₂O, inHg, ftH₂O, oz/inch², cmH₂O
- Calibration: Multi-point (0,10,15,25 & 50psi) with certificate of calibration
- Display: Backlit LCD 30 x 51mm
- Serial output to PC (requires optional cable)
- Dimensions: 182 x 72 x 30mm (L x W x D)
- Weight: 150g
- Battery: 9V, PP9 or equivalent
- Protective rubber boot including stand and magnetic holder
- Auto-Power off function
- Supplied with VKIT-DMA-003 inlet adaptor



Simplifies GC
pressure testing



Includes VKIT-DMA-003
inlet adaptor

About V:Kit

V:Kit specialise in delivering solutions for Analytical Instrument Qualification. With a comprehensive range of measuring tools, software, protocols, standard operating procedures and certified standards, V:Kit products are used by OEMs, service providers and pharmaceutical laboratories worldwide.

Take control of your qualification needs with V:Kit.



FT4 Powder Rheometer® - the world's most versatile instrument for measuring powder flow properties and powder behaviour

Understand how powder flow relates to tablet compression, mixing, wet granulation end point and scale up, hopper flow, DPI performance, segregation, and much more

Optimise formulation, Process Understanding and Control, Scale-up, Tech Transfer, and QA

• **Four testing methodologies in one instrument**

- Unique Dynamic Flow
- Fully Automated Shear Cell
- Bulk Properties
- Processing Variables

- Fully automated test programs and data analysis
- Conditioning mode provides unparalleled repeatability
- Range of sample size, down to 1ml

Example Methods and Data

Basic Flowability

Used for measuring the effect of:

- Flow Additives
- Wet Granulation End Point
- Moisture Content
- Attrition / Segregation
- Physical properties
- Electrostatic Charging

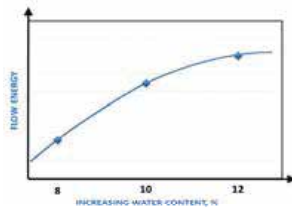

Consolidation

- Direct Pressure
- Tapped

Understanding the effects of:

- Transport
- Storage
- Processing
- Caking

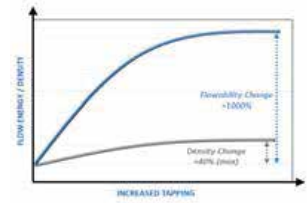

Aeration

Used for measuring:

- Cohesion
- Low stress, gravitationally induced flow
- Dosing / Mass Uniformity
- Aerosolisation / DPI
- Fluidisation behaviour
- Blending / Mixing
- Segregation potential

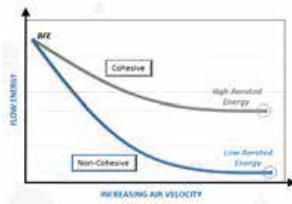

Shear Cell

- Unconfined Yield Strength
- Flow Function
- Cohesion
- 1ml Shear Cell
- Hopper Design

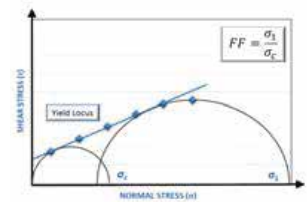

Additional Measurements

- Wall Friction
- Compressibility
- Permeability
- Density (Conditioned / Tapped)

Applications

The FT4 has application in all powder processing industries, including Pharmaceuticals, Fine Chemicals, Food, Cosmetics, Toners, Metals, Ceramics, Plastics, Powder Coatings, Cements and Semiconductors. Applications extend to:

- Die / Capsule Filling
- Tablet Compression
- Hopper Flow
- Wet Granulation End Point & Scale Up
- Flow Additive Selection & Optimisation
- Humidity Effects
- Electrostatic Charge
- Mixing / Blending
- Feeding
- Segregation
- Attrition
- Dry Powder Inhalers
- Caking
- Milling
- Conveying
- Wall Friction & Adhesion
- Hopper Design
- Compact Hardness & Payoff
- Vacuum Filling
- Agglomeration

Alltech® 3300 ELSD

Simplify Detection of Difficult Compounds

sensitive

Low nanogram detection limits

simple

Easiest to use and maintain

small

Integrates easily with any HPLC



ELSD Advantages

ELSD Advantages Over Other LC Detectors

	ELSD	RI	UV	MS	CHART KEY
Sensitivity	●	○	●	○	Excellent: ●
Gradient Capability	●	○	●	○	Good: ◐
Baseline Stability	●	○	●	○	Poor: ○
Solvent Interference	●	○	●	○	
Mass Balance	●	○	●	○	

Introduction To ELSD

Leading the Way in ELSD Technology for More than 25 Years

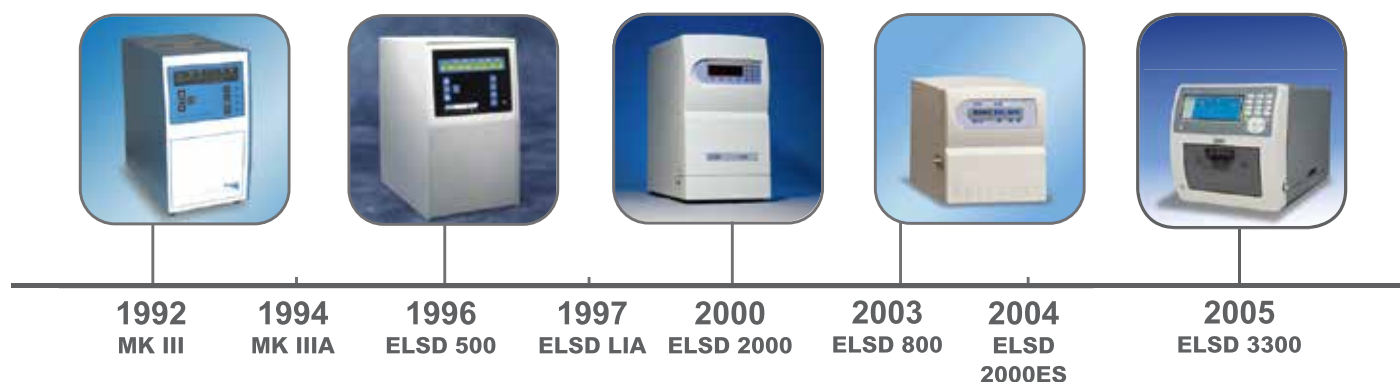

ELSD Advantages

Universal

- Have confidence you're seeing everything in your sample
- Improve quantitative measurements
- Estimate purity more accurately

Sensitive

- Detection limits in the low nanogram range

Gradient Compatible

- Maintain stable baselines during steep gradients

Alltech® ELSDs simplify analysis of difficult compounds:

- pharmaceuticals
- impurities
- phospholipids
- fatty acids
- surfactants
- nutraceuticals
- excipients
- amino acids
- triglycerides
- polymers
- carbohydrates
- peptides

ELSD Detection Process:

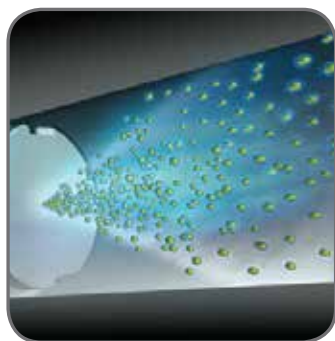

1. Nebulization

Column effluent passes through a needle and mixes with nitrogen gas to form a dispersion of droplets.

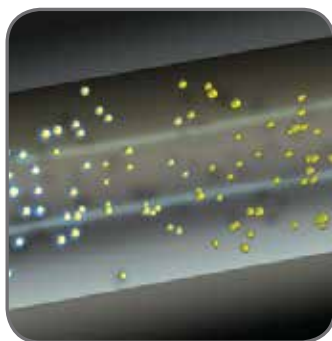

2. Evaporation

Droplets pass through a heated "drift tube" where the mobile phase evaporates, leaving a fine mist of dried sample particles in solvent vapor.

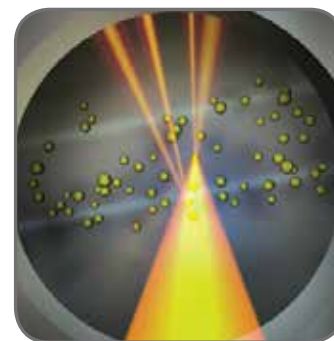

3. Detection

The sample particles pass through a cell and scatter light from a laser beam. The scattered light is detected, generating a signal.

oil free air compressors

Sophisticated use of clean and dry compressed air in laboratories, as well as in dental and medical environments, results in an increasing demand for high quality oil-less air compressors. JUN-AIR's extensive range complies with the company's traditional values - low noise level, reliability and long lifetime. Easy maintenance, a unique cooling system and wear-resisting piston rings ensure, even under extreme conditions, 100% continuous operation and a minimum lifetime of 8,000 hours.

All receivers for oil-less compressors are internally powder-coated in order to avoid corrosion, ensuring high air quality throughout the lifetime of the receiver. Having the lowest noise and vibration level in the market, JUN-AIR compressors are suitable for installation directly at or near the place of use.



Model OF302-25B

The unit includes numerous outlet ports (OF302), offering connection in various directions. At the same time, the adjustable footprints facilitate the replacement of the motor on existing units. Furthermore, the motor may be mounted horizontally by means of a special bracket. The OF300 compressor is the obvious choice for integrated solutions and OEM-applications.

Flexibility is one of the key features of the oil-less series. The ranges are available as separate compressor units or as complete solutions. The compact OF300 motor may be placed in any plane and the adjustable footprints allow retrofitting of existing installations. Adjustable feet, multiple outlet ports and mounting positions, make the OF series the perfect choice for integrated, customized solutions.

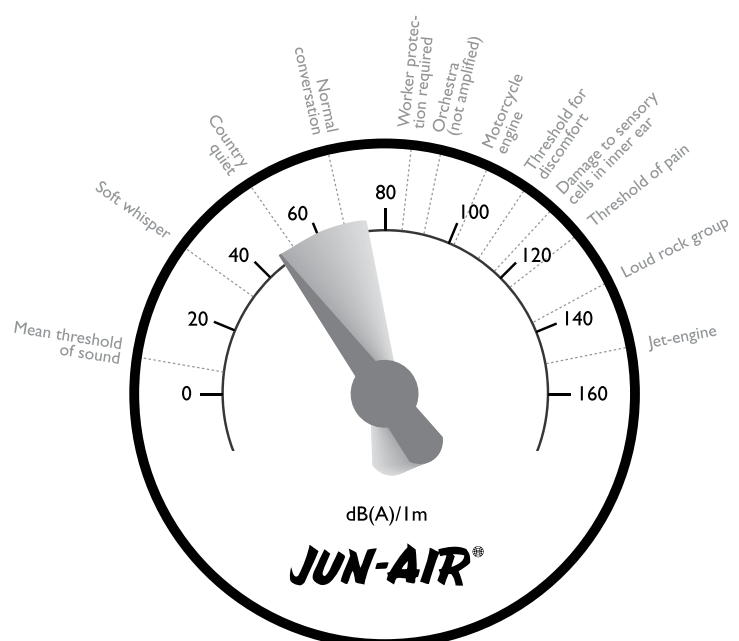

Noise level for oil-less compressors

clean air in cabinets

The oil-less JUN-AIR compressors are available in protective metal cabinets. The cabinets reduce the sound emission from the already quiet oil-less compressor to a level that is approximately one quarter of the level of basic compressors. The cabinets are designed individually for each model with an aesthetic look and with usability, hygiene as well as easy maintenance in mind. All cabinets of the M-range are equipped with rubber castors, enabling easy re-arrangement of installations and thus providing a high degree of flexibility.

The M cabinets are treated with a matt textured powder coating which is hard wearing and enables easy cleaning. The colour of the cabinets is RAL 9002, making the compressors blend naturally with the equipment found in most laboratory, medical and other environments.



Model OF1202-40MQ3



Removal of the top without use of tools



The design ensures easy maintenance



Easy access to the compressor by use of a coin etc.

quiet air



Model 6-25



Model 3 motor



Model 18-40

When a reliable supply of quiet compressed air is required, JUN-AIR's oil-lubricated range of compressors is the perfect choice. The noise level is as low as 35 dB(A) - far below the level of normal conversation.

Our quiet, vibration-free and reliable compressors have a compact design and are easily mounted at the place of use.

The oil-lubricated piston compressor is supplied ready for use with a range of receiver sizes.

The unique synthetic SJ-27F oil designed especially for JUN-AIR optimizes the lubrication of the oil-lubricated JUN-AIR compressors. Furthermore, the internal motor part is mounted in a closed motor house, reducing the noise level even further. Due to the design of the motor, the oil is also used for cooling the motor.

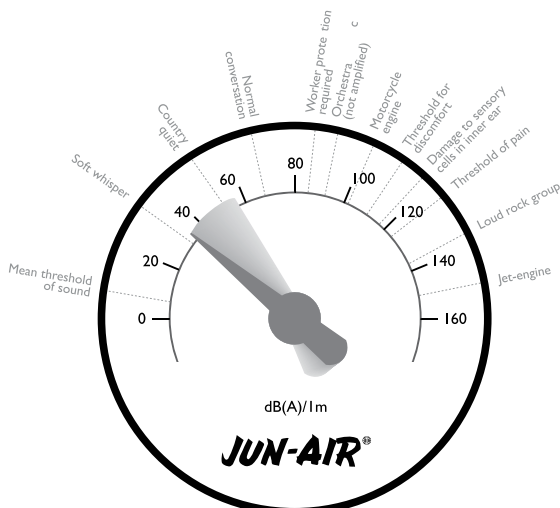

Noise level for oil-lubricated compressors



combination filter

The combination filter combines a powerful 0.01 μm coalescing filter with a highly efficient activated carbon filter as an option to the standard 5 μm and 0.01 μm filters.

Obvious benefits when mounting a combination filter on your compressor:

- Provides high quality, clean compressed air
- Enhances health and safety
- Reduces maintenance costs on your equipment
- Removes the presence and smell of oil
- Easy to mount

All compressed air systems use atmospheric air often contaminated with dirt, water vapour and bacteria. Additionally, acidic oil from the lubricating system of the compressor and wear particles may be added to the air. Furthermore, particles of corrosion will be transferred inside the compressed air system.

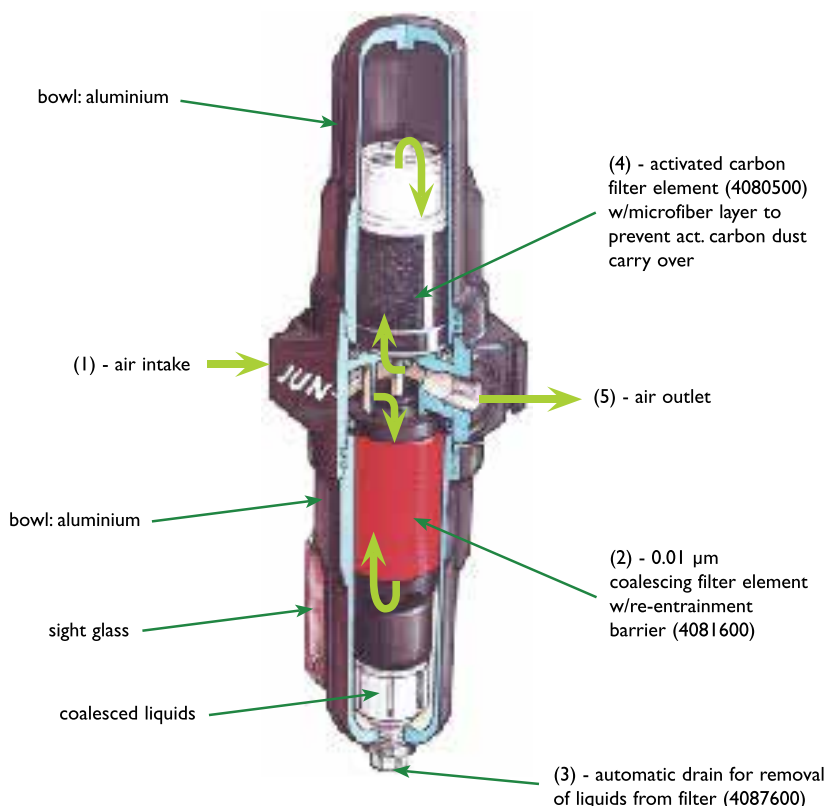

This combination of dirt, oil and water contamination will become an abrasive liquid, which rapidly wears the pneumatic tubing, blocks valves and corrodes piping systems leading to:

- Costly air leaks
- Increased maintenance costs on your equipment
- Unnecessary wear of external equipment
- Polluted air getting in direct contact with the user of the air

Combination filters from JUN-AIR provide air 1,000,000 times cleaner than the air we normally breathe



Manifold kit provides a convenient, cost effective way to collect waste from multiple HPLC machines.

HPLC Safety Disposal Cans

Quick-disconnect fittings and coalescing carbon filters keep laboratory and personnel safe with a compliant, environmentally-friendly solution to waste collection

Ideal for HPLC waste applications:

- Vapor and fire protection
- Safeguard against accidental spills
- Maximize safety and convenience

Hands-free solvent collection: Solvent flows freely from your process into the container through tubing making it suitable for either pump-fed or gravity-flow HPLC waste methods. Two disconnect fittings, one intake and one vent, eliminate back pressure in liquid flow disposal line and provide controlled handling of vapor.

Durability and safety: Translucent polyethylene container allows quick visual inspection of liquid level. Pouring spout is equipped with a stainless steel flame arrester, which reliably dissipates heat to prevent flashback ignition. Spring-loaded, sealed lid automatically vents to guard against explosion. Control odors with a coalescing/carbon filter.

Quick-Disconnect system: Easy-on, easy-off mechanism offers detachment of the can from the process without leaks, drips or vapor release. Once disconnected, the container is automatically sealed to prevent spills.



Coalescing carbon filter
Optional filters are for use with only round style cans.

Optional manifold.....

Valved quick-disconnect fittings automatically close when decoupled to prevent vapor or liquid release.

Translucent color lets you check liquid level at a glance.....

Oval-style maximizes storage space and features one-handed pouring from narrow 1-7/16-in (36-mm) spout.

Stainless-steel fittings offer PTFE O-rings on standard containers. Also available with EPDM or Viton O-ring seals on customized cans.

Easy-carrying handle with fixed position latch keeps spring loaded cover open for convenient pouring during disposal.

Economically priced polypropylene barbed fittings offer EPDM O-rings.

Large 3-5/8-in (92-mm) opening facilitates controlled pouring into larger vessels for proper hazardous waste disposal. Spout is equipped with a stainless steel flame arrester.

Meets OSHA, NFPA and EPA requirements.

Create custom cans, with up to eight ports, for multiple HPLC units. Call our customer service team at 800-798-9250 to learn more.



Capacity	Dimensions OD x H	Fitting No 1 for Liquid Intake			Fitting No 2 for Vapor Release			Model No	Ship Wt lb/kg
		Material	O-Ring	Tubing* Size ID	Material	O-Ring	Tubing* Size ID		
1 gallon (4 L) oval can	7.75 x 5.25 x 12.75 in 197 x 133 x 324 mm	Polypropylene	EPDM	0.375 in 10 mm	Polypropylene	EPDM	0.375 in 10 mm	12160	2/1
2 gallon (7.5 L) round can	12 x 14.75 in 305 x 375 mm	Stainless Steel	PTFE		Stainless Steel	PTFE		TF12752	7/3
2 gallon (7.5 L) round can		Polypropylene	EPDM		Polypropylene	EPDM		PP12752	
2 gallon (7.5 L) round can		Stainless Steel	PTFE		Stainless Steel	PTFE		TF12755	
5 gallon (19 L) round can	12 x 20 in 305 x 508 mm	Polypropylene	EPDM	Polypropylene	EPDM	PP12755			
5 gallon (19 L) round can		Stainless Steel	PTFE	Stainless Steel	PTFE	BY12755			
5 gallon (19 L) round can with faucet no. 08916						0.25 in 6 mm	12770	12/6	
5 gallon (19 L) round can with faucet no. 08916			0.375 in 10 mm			12771			

*Tubing not supplied with containers.

Coalescing Carbon Filters

Use with HPLC cans to minimize odor, and capture 99% of liquid particulates released in the form of gaseous vapor. Vent filter snaps conveniently into the quick-disconnect fitting. Carbon filter cartridge color indicator beads (top portion) changes from purple to black to indicate when replacement is necessary. Replace the coalescing filter (bottom portion) after three or four carbon filter cycles. Use filters with all 2-gallon (7.5-L), 5-gallon (19-L) and custom-built quick-disconnect cans; not for use with oval style can. Meets EPA 40 CFR 264.173.



Filter Replacement Window



28161

28162

Description	Attachment/Use With	Model No	Ship Wt lb/kg
Coalescing/carbon filter combo with stainless steel fittings	Disconnect cans with stainless steel fittings	28162	2/1
Coalescing/carbon filter combo with polypropylene fittings	Disconnect cans with polypropylene fittings	28161	

Carbon Filter Replacements

Description	Attachment/Use With	Model No	Ship Wt lb/kg
Colormetric/carbon filter 3-Pack replacements	28162 or 28161 Coalescing/carbon filter	28157	2/1

NOTE: When using HPLC carbon filter with FM approved Justrite safety disposal can, the Justrite safety disposal container has not been FM approved or tested in assembly with the HPLC filter attached. However, the container does comply with US OSHA 1910 and NFPA Code 30 requirements, both with and without the HPLC filter. Do not transport safety container while carbon filter is attached.



28157

HPLC PTFE Manifold and Compression Fittings

Enables up to six waste lines (per manifold) from HPLC processes to be fed into a single intake fitting. Safety container with manifold installed is OSHA compliant and meets NFPA Code 30. Use on round containers; not for use on oval style can.



28178



28189



Manifold no. 28177 with stacker no. 28179 and tubing connector package nos. 28188 and 28189.

Description	Attachment/Use With	Model No	Ship Wt lb/kg
PTFE manifold with stainless steel fitting	Containers with stainless steel fittings	28177	2/1
PTFE manifold with polypropylene fitting	Containers with polypropylene fittings	28178	
PTFE manifold with stainless "stacker" connector	28177 or 28178	28179	
OD 0.0625 in hard wall ETFE tubing compression fittings with ferrules (package of six - blue)		28188	
OD 0.125 in hard wall ETFE tubing compression fittings with ferrules (package of six - green)		28189	
OD 2 mm hard wall ETFE tubing compression fittings with ferrules (package of six - yellow)		28121	
OD 2.5 mm hard wall ETFE tubing compression fittings with ferrules (package of six - orange)		28122	
OD 3 mm hard wall ETFE tubing compression fittings with ferrules (package of six - red)		28123	

Polytetrafluoroethylene (PTFE) is a synthetic fluoropolymer. Ethylene tetrafluoroethylene (ETFE) is a fluorine based plastic.



84003 with TF12755

Spill Basin

Durable polyethylene basin keeps work area clean around HPLC cans and captures any inadvertent leakage from HPLC inflow tubes.

1 Year
Limited Warranty

Description	Dimensions W x L x H	Model No	Ship Wt lb/kg
5 gallon (19 L)	14.875 x 14.875 x 7.625 379 x 379 x 194 mm	84003	4/2



Need a stainless steel manifold?

For containers with stainless steel fittings, use a stainless steel manifold that accepts 4 waste lines. Visit our website and search model no. 28168.

VaporTrap™ Solvent Waste Systems NEW

Prevent harmful HPLC vapors from being released into the air

- Carbon filter prevents volatile organic compound vapors from being released into the air
- Two-piece cap design eliminates the need to disconnect tubing from the adapter to install a closed cap
- High-density polyethylene (HDPE) carboy features rectangular ergonomic design, saving valuable bench space

Designed to collect waste from one or more HPLC machines, VaporTrap systems include carbon exhaust filters to trap potentially harmful vapors emitted from solvents, protecting workers from inhaling dangerous fumes. The closed, leakproof system design helps eliminate spills and provides an efficient way for disposing of volatile organic compound waste.

Polypropylene cap with acetal homopolymer adapter offers a wide range of tubing port configurations with and without hose barb ports. Adapter and durable HDPE carboy provide excellent chemical compatibility against aggressive solvents. Unique, convenient features include large top handles for an ergonomic full-hand grip for added safety when moving the carboy, and clear graduation marks with ±5% accuracy.

Each system includes an HDPE carboy, two 83-mm caps (one with ported adapter for waste collection and one closed for safe transport), various ports for waste tubing, one port for a carbon exhaust filter, one carbon exhaust filter, one straight adapter and one 90-degree adapter for filter, tube fittings, gasket, and plugs for unused ports.

Optional filter replacement indicator makes it easy to see when filter is saturated and requires replacement.

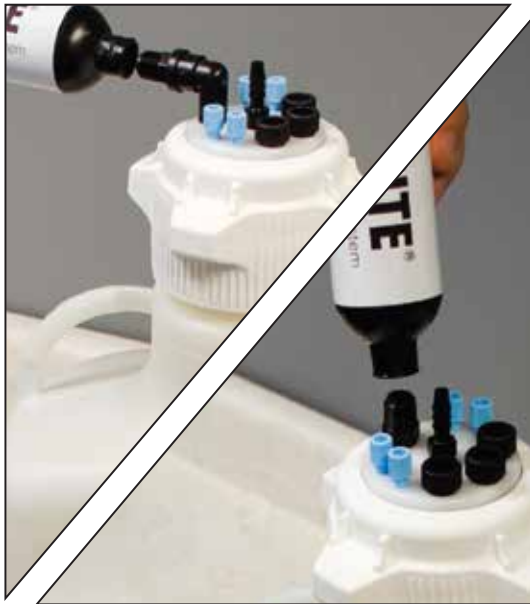

Improve air quality in labs by using a carbon exhaust filter which traps solvent vapors—install in horizontal or vertical position.



Need FM-approved containers?
Visit our website and search on HPLC safety cans, featuring a quick-disconnect system.



Tubing Sizing Guide for Ports

See Tubing Sizing Guide on page 24 to help determine port size needed.

Accessories

Description	Model No	Ship wt lb/kg
Replacement carbon exhaust filter, package of two. Filter size: 1.9 OD x 7"	12849	2/1
Carbon exhaust filter indicator, package of two	12952	1/1
Replacement fittings, six 1/8" fittings and six 1/4" plugs, one pack	12851	

1 Year
Limited Warranty

VaporTrap™ Solvent Waste Systems

Carboy Size	Nominal Dimensions* W x L X H	Material Type	Cap Size	1/8" Tubing OD Ports	1/4" Tubing OD Ports	1/4" or 3/8" Tubing ID Hose Barb Ports	Model No	Ship wt lb/kg
1.1 gallon (4 L)	6.1 x 6.1 x 15.75 in (155 x 155 x 400 mm)	HDPE	83 mm	6	—	—	12800	4/2
1.3 gallon (5 L)	5.2 x 8.7 x 18.75 in (132 x 221 x 476 mm)						12801	
2.6 gallon (10 L)	6.4 x 10.75 x 21.9 in (163 x 273 x 556 mm)						12802	
5.3 gallon (20 L)	8.1 x 13.6 x 26.7 in (206 x 345 x 678 mm)						12803	
1.1 gallon (4 L)	6.1 x 6.1 x 15.75 in (155 x 155 x 400 mm)	HDPE	83 mm	6	—	1	12805	4/2
1.3 gallon (5 L)	5.2 x 8.7 x 18.75 in (132 x 221 x 476 mm)						12806	
2.6 gallon (10 L)	6.4 x 10.75 x 21.9 in (163 x 273 x 556 mm)						12807	
5.3 gallon (20 L)	8.1 x 13.6 x 26.7 in (206 x 345 x 678 mm)						12808	
1.1 gallon (4 L)	6.1 x 6.1 x 15.75 in (155 x 155 x 400 mm)	HDPE	83 mm	4	3	—	12810	4/2
1.3 gallon (5 L)	5.2 x 8.7 x 18.75 in (132 x 221 x 476 mm)						12811	
2.6 gallon (10 L)	6.4 x 10.75 x 21.9 in (163 x 273 x 556 mm)						12812	
5.3 gallon (20 L)	8.1 x 13.6 x 26.7 in (206 x 345 x 678 mm)						12813	
1.1 gallon (4 L)	6.1 x 6.1 x 15.75 in (155 x 155 x 400 mm)	HDPE	83 mm	4	4	—	12815	4/2
1.3 gallon (5 L)	5.2 x 8.7 x 18.75 in (132 x 221 x 476 mm)						12816	
2.6 gallon (10 L)	6.4 x 10.75 x 21.9 in (163 x 273 x 556 mm)						12817	
5.3 gallon (20 L)	8.1 x 13.6 x 26.7 in (206 x 345 x 678 mm)						12818	
1.1 gallon (4 L)	6.1 x 6.1 x 15.75 in (155 x 155 x 400 mm)	HDPE	83 mm	4	3	1	12820	4/2
1.3 gallon (5 L)	5.2 x 8.7 x 18.75 in (132 x 221 x 476 mm)						12821	
2.6 gallon (10 L)	6.4 x 10.75 x 21.9 in (163 x 273 x 556 mm)						12822	
5.3 gallon (20 L)	8.1 x 13.6 x 26.7 in (206 x 345 x 678 mm)						12823	

*Note: Height includes filter oriented in horizontal position.

VaporTrap™ UN/DOT Solvent Waste Systems NEW

UN/DOT solvent waste system ensures safe transport of hazardous liquids

- UN/DOT certified carboy and closed cap for packaging group II, and hazardous chemicals
- Carbon filter prevents volatile organic compound vapors from being released into the air
- Two-piece cap design eliminates the need to disconnect tubing from the adapter to install a closed cap

These UN/DOT solvent waste systems provide liquid waste collection and disposal for single or multiple HPLC machines. Carbon exhaust filter traps potentially harmful vapors emitted from solvents, protecting workers from inhaling dangerous fumes. UN/DOT certified carboy and 70-mm closed cap (UN Rating 3H1/Y1.8/100) are designed for single-use and easy disposal of laboratory waste.

The high-density polyethylene (HDPE) cap with acetal homopolymer adapter offers a wide range of top connection options. Select tubing port configurations to accommodate various tubing sizes and create a closed system preventing leaks or spills. Heavy duty HDPE carboy features a large top handle for an ergonomic full-hand grip, and provides excellent chemical compatibility against aggressive solvents.

Each system includes an HDPE UN/DOT container, two 70-mm caps (one with ported adapter for waste collection and one closed for safe transport), various ports for waste tubing, one carbon exhaust filter, one port for carbon exhaust filter, one straight and one 90-degree filter adapter, tube fittings, EPDM gasket, and plugs for unused ports.



Safely dispose of laboratory waste in these durable, United Nations/Department of Transportation certified carboys—simply remove cap with filter and replace with closed cap for transport.



Optional filter indicator makes it easy to see when filter is saturated and needs replacement.



12846

12841

VaporTrap™ UN/DOT Solvent Waste Systems

Carboy Size	Nominal Dimensions* W x L x H	Material Type	Cap Size	1/16" Tubing OD Ports	1/8" Tubing OD Ports	1/4" Tubing OD Ports	1/4" or 3/8" Tubing ID Hose Barb Ports	Model No	Ship wt lb/kg
3.6 gallon (13.5 L)	9.25 x 11.3 x 13.1 in (235 x 287 x 333 mm)	HDPE	70 mm	6	—	—	—	12836	4/2
5.3 gallon (20 L)	9.25 x 11.3 x 17.5 in (235 x 287 x 445 mm)							12837	5/2
3.6 gallon (13.5 L)	9.25 x 11.3 x 13.1 in (235 x 287 x 333 mm)	HDPE	70 mm	—	6	—	—	12838	4/2
5.3 gallon (20 L)	9.25 x 11.3 x 17.5 in (235 x 287 x 445 mm)							12839	5/2
3.6 gallon (13.5 L)	9.25 x 11.3 x 13.1 in (235 x 287 x 333 mm)	HDPE	70 mm	—	6	—	1	12840	4/2
5.3 gallon (20 L)	9.25 x 11.3 x 17.5 in (235 x 287 x 445 mm)							12841	5/2
3.6 gallon (13.5 L)	9.25 x 11.3 x 13.1 in (235 x 287 x 333 mm)	HDPE	70 mm	—	4	3	—	12842	4/2
5.3 gallon (20 L)	9.25 x 11.3 x 17.5 in (235 x 287 x 445 mm)							12843	5/2
3.6 gallon (13.5 L)	9.25 x 11.3 x 13.1 in (235 x 287 x 333 mm)	HDPE	70 mm	—	4	4	—	12844	4/2
5.3 gallon (20 L)	9.25 x 11.3 x 17.5 in (235 x 287 x 445 mm)							12845	5/2
3.6 gallon (13.5 L)	9.25 x 11.3 x 13.1 in (235 x 287 x 333 mm)	HDPE	70 mm	—	4	3	1	12846	4/2
5.3 gallon (20 L)	9.25 x 11.3 x 17.5 in (235 x 287 x 445 mm)							12847	5/2

*Note: Height includes filter oriented in horizontal position.

UN/DOT Approved Carboys

Capacity	Nominal Dimensions W x L x H	Material Type	Cap Size	Model No	Ship wt lb/kg
3.6 gallon (13.5 L)	9.25 x 11 x 11 in (235 x 279 x 279 mm)	High-density polyethylene	70 mm	12950	3/1
5.3 gallon (20 L)	9 x 11 x 15.5 in (229 x 279 x 394 mm)			12951	4/2

Accessories

Description	Model No	Ship wt lb/kg
Replacement carbon exhaust filter, package of two. Filter size: 1.9 OD x 7"	12849	2/1
Carbon exhaust filter indicator, package of two	12952	1/1
Replacement fittings, six 1/8" fittings and six 1/4" plugs, one pack	12851	

CLOSED SYSTEMS INTRODUCTION

Through leaks, spills, and ventilation, an "open" solvent-using system will release solvent vapors directly into the laboratory environment. This introduction may be reduced by adding several key components to the typical system. These items are:

- A properly sealed solvent reservoir with ventilation control
- A solvent waste container with secure fluid connections
- A carbon filter to reduce vapors escaping the waste container

EXAMPLE OF A CLOSED SYSTEM HPLC

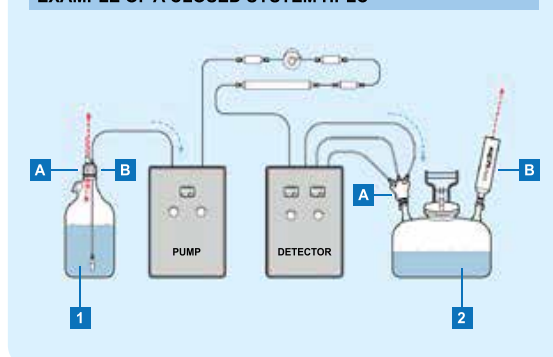

1: Solvent Reservoir
2: Waste Container
A: Fluid Connections
B: Air inlet (1) or vent (2)

1A SOLVENT RESERVOIR FLUID CONNECTIONS

For a closed system on a bottle, each container first requires a bottle cap with ports to fit the specific tubing sizes. When using caps with threaded ports for fittings, the fittings may be selected and replaced to accommodate different diameters of tubes. Caps with "slip-through" ports (non-threaded holes drilled or molded into a cap) are acceptable, provided the holes fit the tubing sizes securely. Most slip-through caps are made to accommodate 1/8" or 1/16" OD.

1B SOLVENT RESERVOIR AIR INLET

In systems where sparging¹ is not employed, to complete the closed system on a bottle each container requires a device to control the bottle cap vent. A closed bottle must function exactly like a coffee travel mug – liquid goes out through one hole, and air comes in through a pinhole to displace the liquid removed. To manage the air flow, the simplest answer is a check valve assembly made to occupy a bottle cap port. The check valve allows air to enter a bottle as the pump moves the liquid phase out to the system. It also minimizes escape of vapors contained in the bottle. Should the bottle ever be exposed to pressure – a result of a rise in lab temperature (over a warm weekend, for example) or a sparging line accidentally connected – to reduce the threat of explosion a check-and-relief valve assembly is also available. The relief function allows pressure to escape while still preserving a "pressure blanket" of 0.5-1psi in the bottle. Although VapCheck™ units resist many standard solvents, care should be taken to consider the chemical compatibility of a solvent with VapCheck™ materials.

2A WASTE CONTAINER FLUID CONNECTIONS

Many labs are standardizing on Justrite® 2- and 5- gallon HPLC Centura™ waste containers. These safety cans have enough capacity for days or weeks of typical flow, vent automatically at 5 psig if pressurized, and allow users to disengage waste lines and vapor filters quickly during waste collection. Containers are available with either Polypropylene or Stainless Steel quick disconnects. Care should be taken when choosing the disconnect type. For example, at high concentrations the solvent Hexane swells Polypropylene as much as 30%, causing the disconnect to "stick" and restrict fluid flow. Containers and manifolds with stainless steel quick disconnects are advised wherever such chemical compatibility issues may arise; consult a chemical compatibility guide before selecting a container. One should also note that Justrite containers must be grounded while in use and especially while emptying the container, as static electricity has been known to ignite solvent fumes.

For labs which choose not to use Justrite® containers, Vaplock™ products are also available to adapt to standard drum and pail closures, as well as Nalgene® 83B, 53B, and 100-415 carboys. PLEASE NOTE THAT IT IS NOT POSSIBLE TO GROUND DRUM, PAIL, GLASS BOTTLE AND CARBOY (NON-JUSTRITE®) CONTAINERS; THIS MAY RESULT IN A SAFETY HAZARD WITH FLAMMABLE SOLVENTS.

The type and dimension of waste tubing found on an HPLC varies widely, depending on both system and user requirements. Outer and inner diameters range from microns to inches, and tubing material may be hard- or soft-wall plastic, metal, smooth-walled or corrugated. All these lines must be connected to a waste container. Adapting securely, without leaks and vapor release, poses a problem when attempting a closed system. VapLock™ manifolds adapt to tubing sizes up to 1/2" ID or OD (and larger if necessary) and can be stacked to accept additional lines. Most manifold ports permit direct connection of 1/4" or 1/2" threaded NPT fittings.

2B WASTE CONTAINER VAPOR VENT

The most significant vapor generator in an HPLC system is the waste can, where solvents draining to the container may volatilize rapidly as solvent entering the container forces vapor into the laboratory. Activated carbon has excellent adsorptive properties for organic solvents. With a Gas Chromatograph, a number of carbon types were tested for vapor breakthrough under a flow of Acetonitrile vapor, one of the more common solvents used in HPLC. After determining the appropriate type, the carbon was similarly tested on other common solvents. The breakthrough data published in this

ANTISTATIC WIRES

REDUCE FIRE RISKS FROM STATIC ELECTRICITY

Antistatic wires reduce spark danger from static electricity generated by movement and flow of flammable liquids. Bonding between containers during liquid transfer, and connecting drums to an earth ground are required under Federal and local codes.



JT-08500
Antistatic wires with 3' cable

¹ "Sparging" involves pressurizing a bottle with a blanket of gas, usually helium.

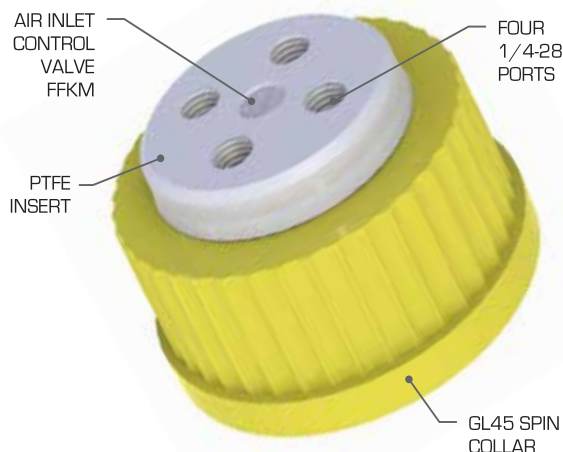

SV-306 GL45 CLOSED SYSTEM CAP 4-PORT WITH FFKM AIR INLET VALVE

- Minimize solvent vapor entering the lab
- Reduce leaks and spills of solvent waste
- HPLC Normal and Reverse Phase solvent compatibility

SV-306 is designed to fit standard GL45 threaded lab bottles. Tubing that is 1/8" OD or smaller may be connected to the ports with the appropriate 1/4-28 fitting and ferrule set. The design includes a free-spinning cap collar to prevent tubing from twisting when the cap is removed. Tighten tube fittings (not included) until snug, but do not overtighten to avoid stripping of the port threads.

With chemically resistant PTFE and FFKM perfluoroelastomer components, this cap is designed to resist most standard Normal and Reverse phase HPLC solvents, such as Acetonitrile, THF, and Methylene Chloride. Materials of construction include a PTFE insert with Polypropylene spin collar and expanded PTFE gasket. Air inlet valve is PTFE, 300-series stainless steel, and FFKM elastomer. Compatibility of materials and solvents used is the responsibility of the user.

Although a gasket may not be required for an adequate seal, replacement gaskets may be purchased under part number BC-015-01. Expanded PTFE will provide an inert sealing option, but will compress over time with repeated use. Replacement air inlet valve filters are part number FR-008; remove and replace as necessary.



WESTERN FLUIDS

CHEMICAL COMPATIBILITY DATA

SOLVENT	PTFE	POLYPROPYLENE	300 STAINLESS	VITON®	EPDM	FFKM
ACETONE	A	A	A	NR	A	A
CHLOROFORM	A	NR	A	A	NR	A
ETHYL ACETATE	A	A	A	NR	B	A
HEXANE	A	BC	A	A	NR	A
MEK	A	A	A	NR	A	A
METHYLENE CHLORIDE	A	NR	C	B	C	A
THF	A	BC	A	NR	NR	A
ACETONITRILE	A	AB	A	NR	A	A
IPA	A	A	A	A	A	A
METHANOL	A	A	A	C	A	A

A = EXCELLENT B = GOOD C = FAIR TO POOR NR = NOT RECOMMENDED

The data above has been compiled from a number of sources and is intended as a general guide only. Chemical compatibility of solvents and materials employed is the responsibility of the user. Data assumes room temperature use.

AIR AND VAPOR FLOW DIAGRAM

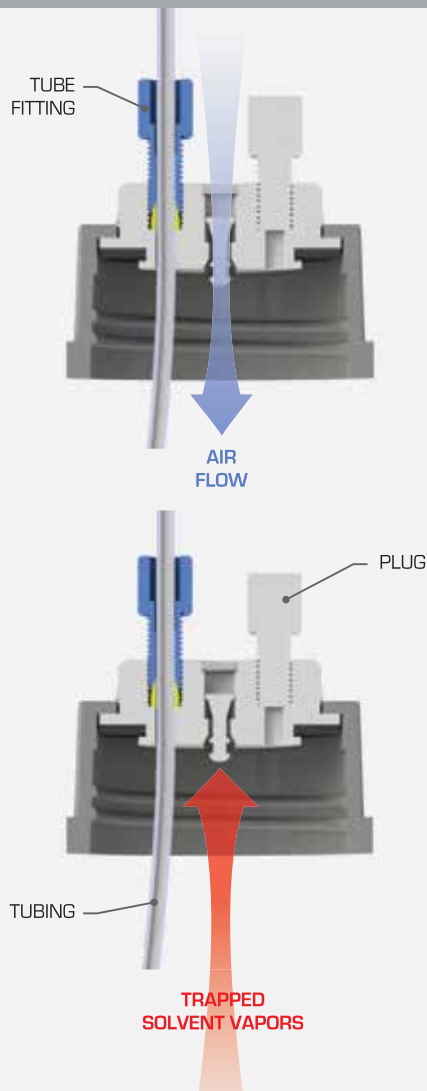

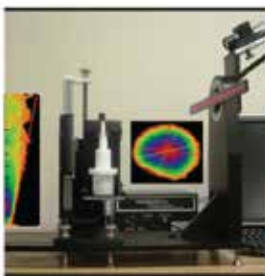
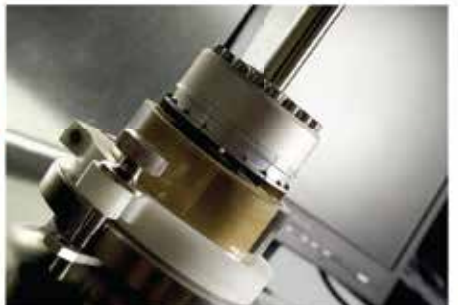

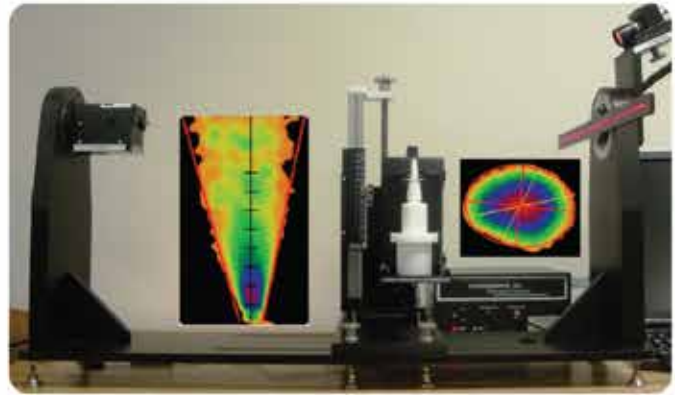

Apex Chromatography is one of India's leading distributors for Analytical consumables, Inhalation testing products, High end instrumentation, Filtration equipment, Laboratory Health and Safety products. Having built our reputation of excellent service, maintaining high levels of stock for a wide portfolio of products, with offices and representation in various cities across the country and a highly trained, dedicated back office team. We are the complete solution for all your analytical needs.

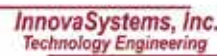

Authorised Distributors in India :



Apex Chromatography Pvt. Ltd.

The complete solution for all your analytical needs

HYDERABAD OFFICE :
Plot No. 35, Street No. 3
Sagar Society, Banjara Hills
Hyderabad - 500034. Telangana
Phone: +91-40-23559697 / 98
+91-98481 77772
E-mail: sales@apexchrom.com

MUMBAI OFFICE :
102, A-Wing, Mangalya Building
Off Marol Maroshi Road, Andhari East,
Mumbai - 400059. Maharashtra, India
Phone: +91-22-29209697 / 98
+91-96191 77772
E-mail: sales.mumbai@apexchrom.com



•Ahmedabad •Aurangabad •Bangalore •Delhi •Goa •Hyderabad •Mumbai •Pune •Vizag

www.apexchromatography.com